

Salizturīgs betona puķu pods. Puķu podi un puķu dobes ļauj augus padarīt mobīlus, kas ir ļoti ērti ziemas sezonā, kad augs ir jāpasargā no aukstās temperatūras, tos ir vieglāk aplaistīt un mēslot. Šādi puķu podi var kalpot kā norobežojošs elements.

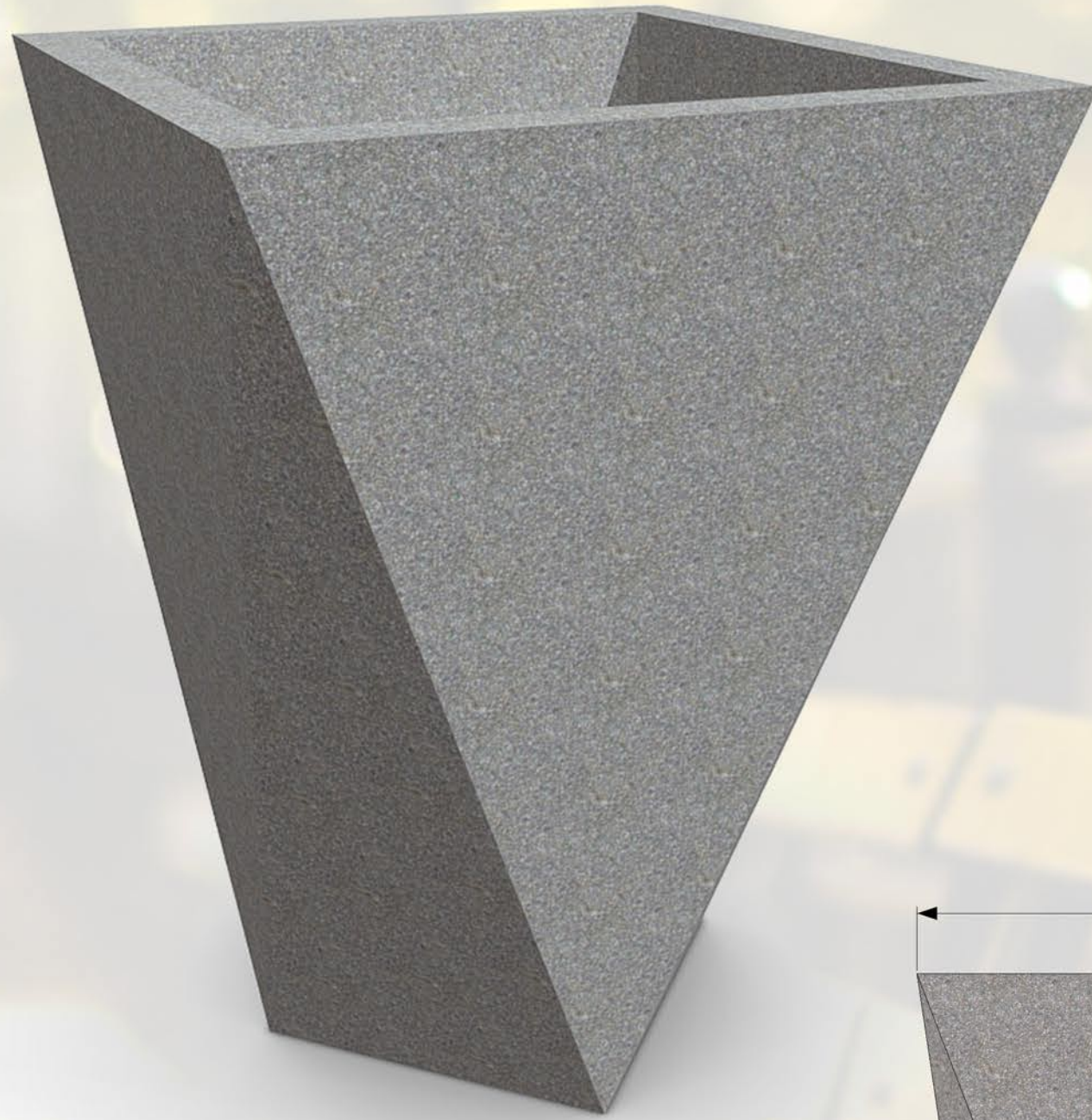

Ar epoksīda apdari

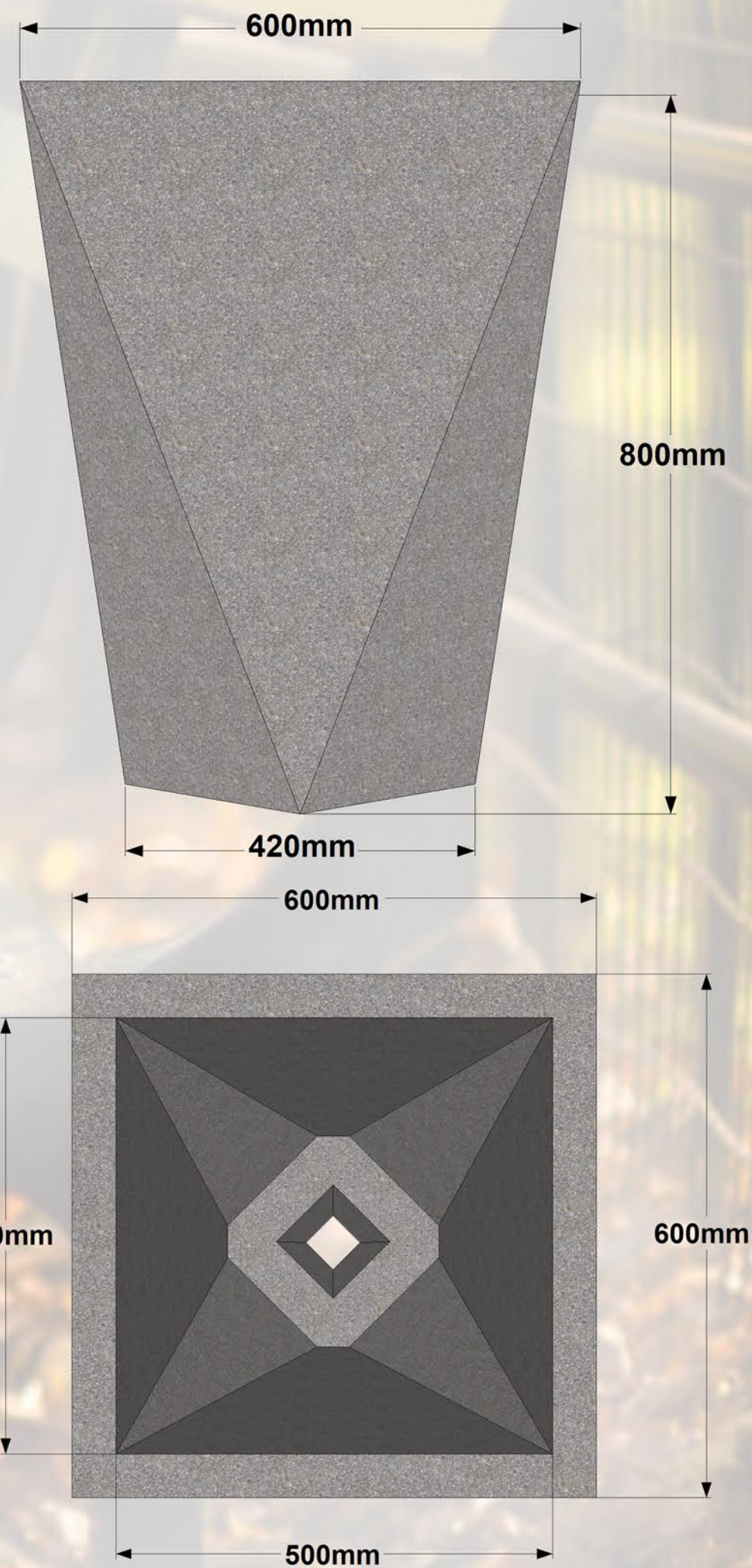
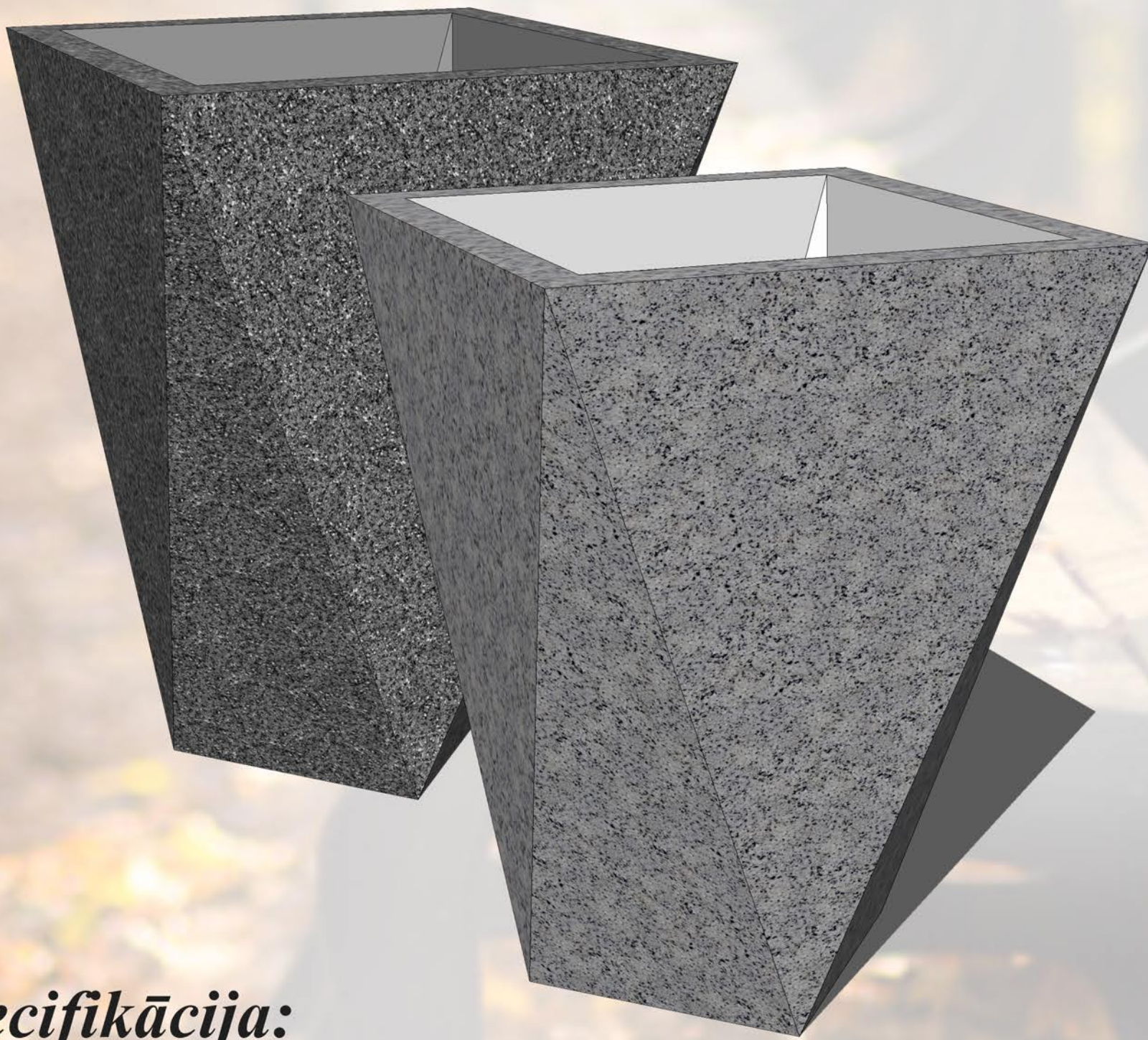

Specifikācija:

Betons - salizturīgs betons...

Apdare - epoksīda apdare...

Epoksīda apdares toņi

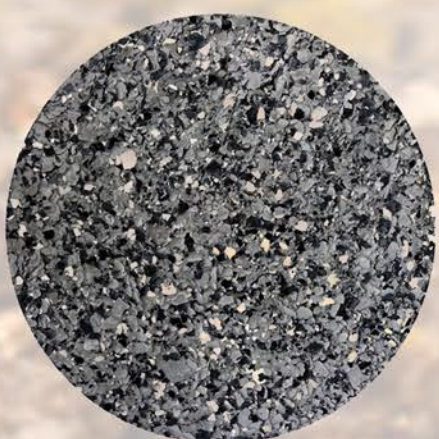

RG-1

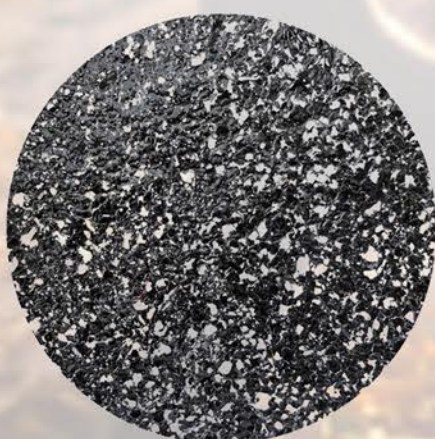

RG-2

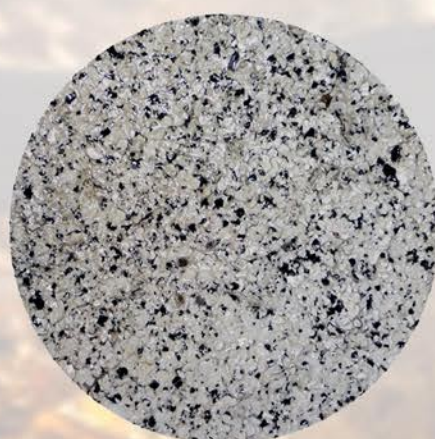

RG-3

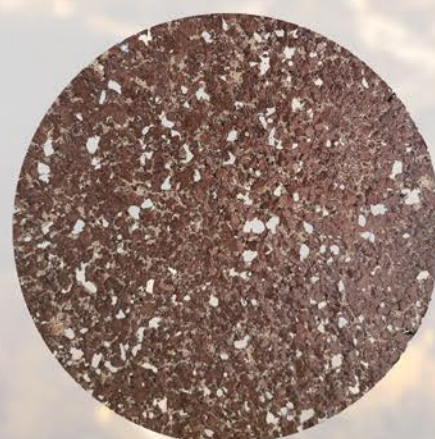

RG-4



DĀRZIEM UN PARKIEM